

### LISTA DE RECAMBIOS / LIST OF SPARES

Nº Artículo Item No	Descripción Description	Ref. repuesto Spare part ref.
1	Carrocería Bodyshell	ER0044/01
2	Set accesorios carrocería Bodyshell accessories set	ER0043/02
3	Pistones Pistons	ER0035/03
4	Circuito impreso Printed circuit board	ER0043/05
5	Engranaje con eje Gear with axle	ER10100/06
6	Set motor Motor set	ER0040/07
7	Bloque bastidor Chassis	ER0035/08
8	Set de bielas Rods set	ER10100/09
9	Set de ruedas Wheel sets	ER0044/10
10	Base bastidor con tomas de corriente Chassis bottom include current pick-ups	ER0035/12
11	Enganche Coupling	ER058
12	Caja enganche (x2) Coupler box (x2)	ER10100/14
13	Caja enganche larga (x2) Large coupler box (x2)	ER0043/13

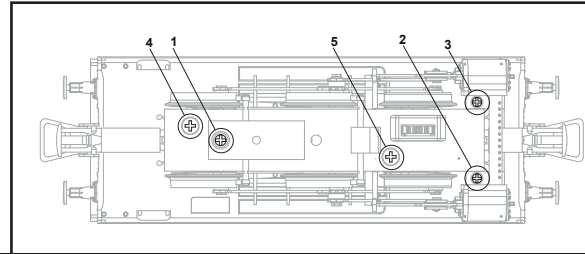
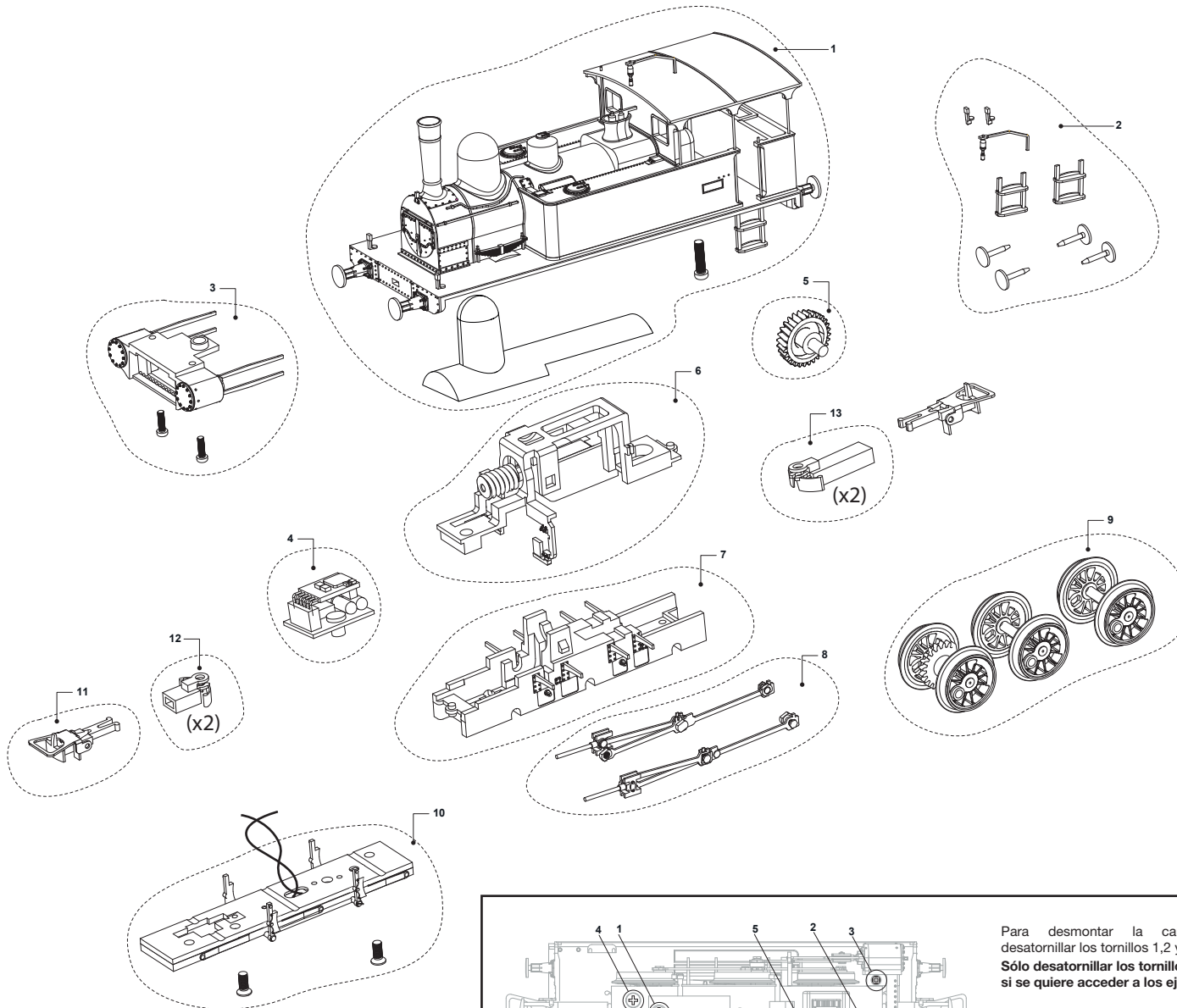

Para desmontar la carrocería, desatornillar los tornillos 1, 2 y 3. **Sólo desatornillar los tornillos 4 y 5, si se quiere acceder a los ejes.**

To open this locomotive please remove the screws 1, 2 and 3. **Do not remove the screws 4 and 5 unless you want to remove the wheel sets.**