

## LISTA DE RECAMBIOS / LIST OF SPARES

Nº Artículo Item No	Descripción Description	Ref. repuesto Spare part ref.
1	Carrocería Bodyshell	ER0038/01
2	Set accesorios carrocería Bodyshell accessories set	ER10100/02
3	Pistones Pistons	ER0038/03
4	Contrapeso Weight	ER10100/04
5	Circuito impreso Printed circuit board	ER0038/05
6	Engranaje con eje Gear with axle	ER10100/06
7	Set motor Motor set	ER0035/07
8	Bloque bastidor Chassis	ER0035/08
9	Set de bielas Rods set	ER10100/09
10	Set de ruedas Wheel sets	ER0038/10
12	Base bastidor Chassis bottom include current pick-ups	ER0038/12
13	Enganche (x2) Coupling (x2)	ER058
14	Caja enganche (x2) Coupler box (x2)	ER10100/14

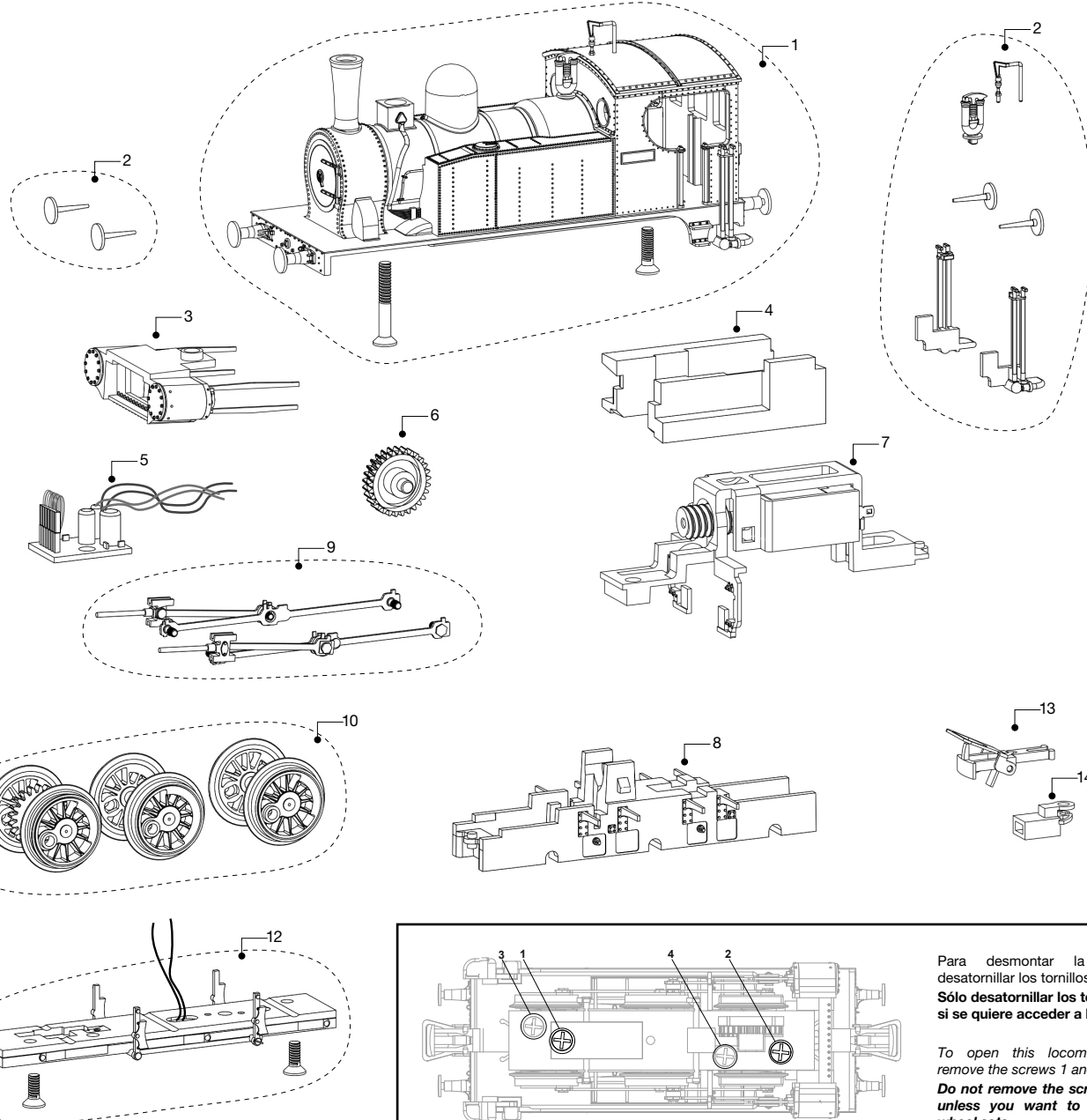

Para desmontar la carrocería, desatornillar los tornillos 1 y 2. **Sólo desatornillar los tornillos 3 y 4, si se quiere acceder a los ejes.**

To open this locomotive please remove the screws 1 and 2. **Do not remove the screws 3 and 4 unless you want to remove the wheel sets.**